

STREAM AMP 100

OWNER'S MANUAL

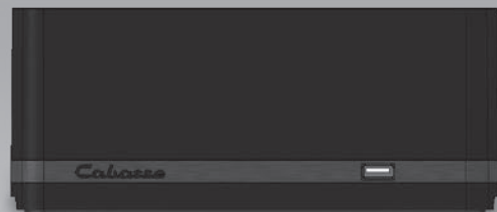

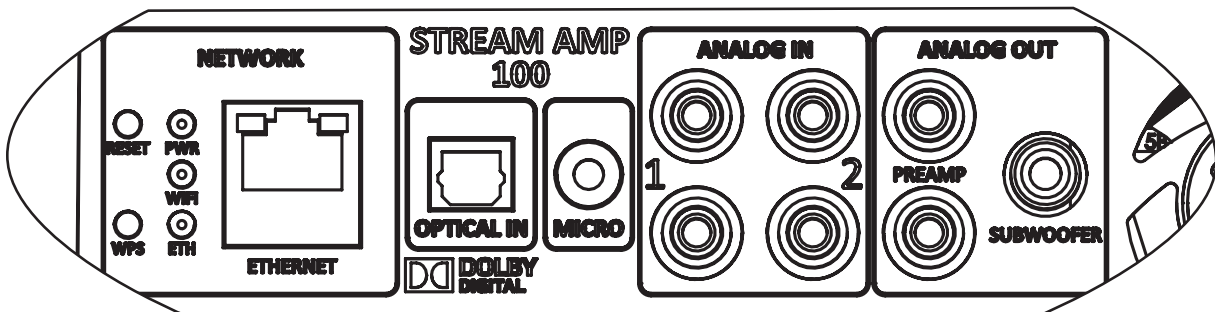
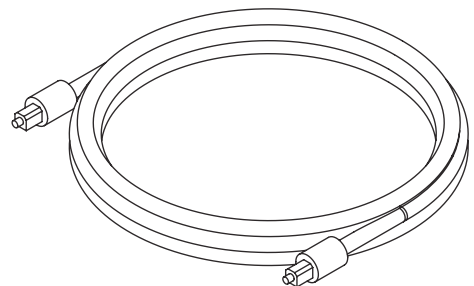
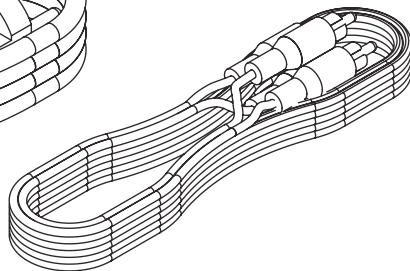
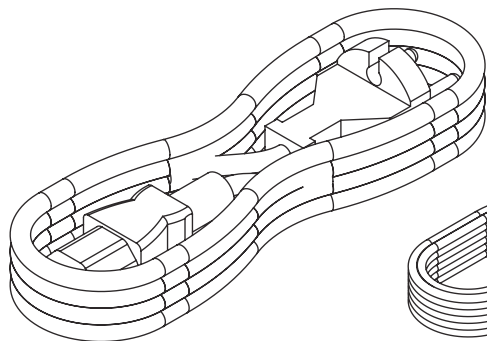
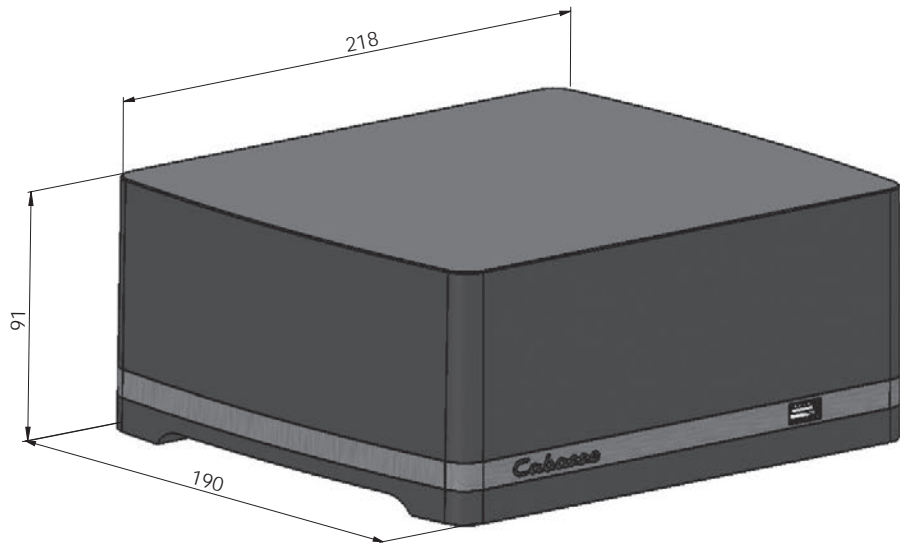

Cabasse

www.cabasse.com

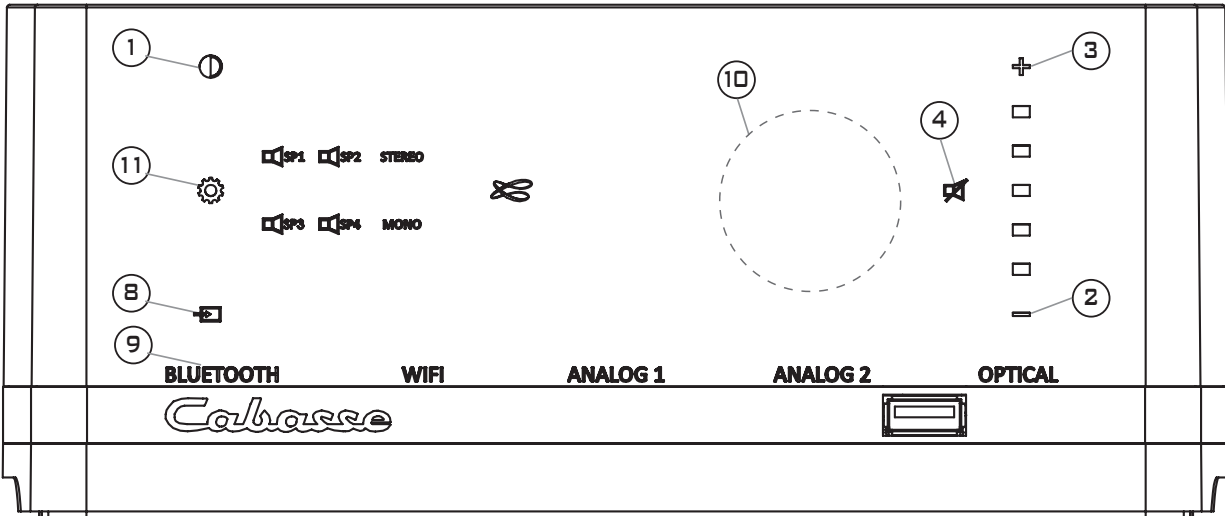



		IDENTIFYING CONTROLS
1	LED DISPLAY	ON (white LED) / ECO (red LED)
2	VOL -	Volume DOWN
3	VOL +	Volume UP
4		Mute on/off
8		Source selection
9	SOURCES	BLUETOOTH - WIFI (WLAN/LAN) - RCA ANALOG 1 - RCA ANALOG 2 - OPTICAL
10		Position of the NFC patch

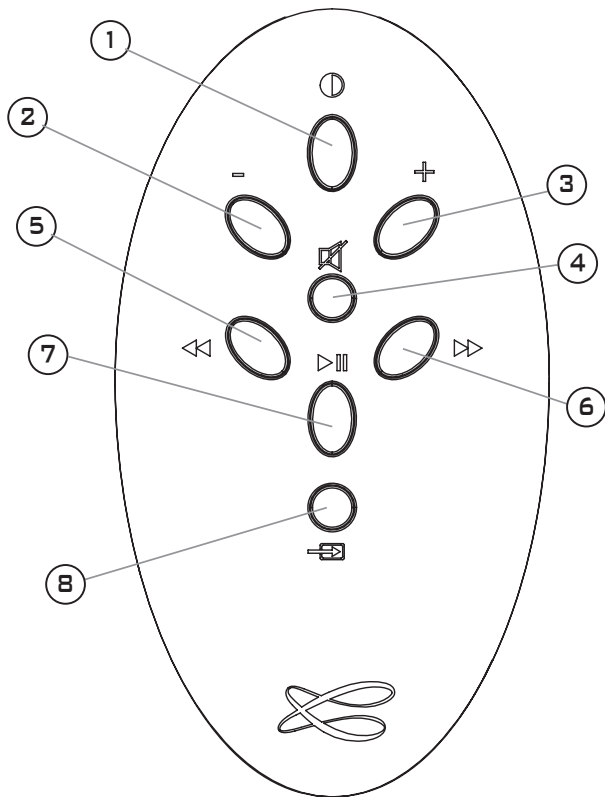

		IDENTIFYING CONTROLS
1		ON / ECO
2	VOL -	Volume DOWN
3	VOL +	Volume UP
4		Mute on/off
5		Previous title of the played album
6		Next title of the played album
7		Pause/Play
8		Source selection

FEATURES

	Bluetooth connection	WIFI/ETHERNET via internet router	WIFI direct to smartphone/tablet
Loss less audio playback		<input type="checkbox"/>	<input type="checkbox"/>
Access to any audio from WLAN network (desktop...)		<input type="checkbox"/>	
Multi-room		<input type="checkbox"/>	
Tracks playback from smartphone/tablet	<input type="checkbox"/>	<input type="checkbox"/>	<input type="checkbox"/>
Playback smartphone/tablet a audio applications (youtube...)	<input type="checkbox"/>		
Playback from USB device		<input type="checkbox"/>	<input type="checkbox"/>
Web radio /DEEZER		<input type="checkbox"/>	



Manufactured under licence from Dolby Laboratories.
Dolby and the double D symbol are trademarks of Dolby Laboratories.

QUICK PLUG & PLAY

- ① Place the STREAM AMP on a solid shelf close to a mains plug, with enough available headroom above, under and around, for the optimum efficiency of the Bluetooth and WIFI antennas and proper ventilation of the amplifier.

Connect 2 or 4 loudspeakers to the STREAM AMP. For a single pair of loudspeakers, use SP1 (right speaker) and SP2 (left speaker) binding posts.

CAUTION: be assured that all “+” inputs are effectively connected to “+” outputs as well as all left outputs to left inputs.

Impedance range selector:

Position “I” (factory preset): power output is 2 x 50 W or 4 x 25 W RMS for loudspeakers with a minimum impedance value below 6.4 ohms. It goes down to 2 x 25 W and 4 x 12.5 W for loudspeakers with minimum impedance value above (or equal to) 6.4 ohms.

Position “II” : use this position to get 2 x 50 W or 4 x 25 W RMS with minimum impedance value above (or equal to) 6.4 ohms, for instance Cabasse Antigua IW or Archipel models.

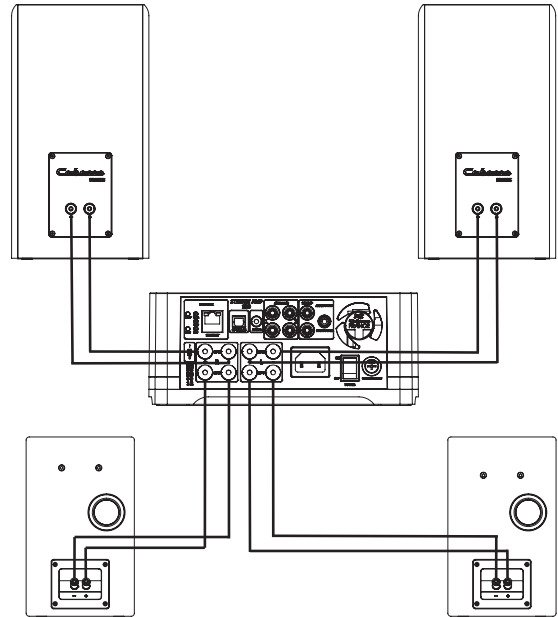

- ② Connect the power cable to the STREAM AMP, plug it to the mains and position the POWER ON/OFF switch on "ON". STREAM AMP is ready to play when the LED ① turns on. Press key ① either on the STREAM AMP or the remote to get STREAM AMP on.

NOTE: the DLNA mode of STREAM AMP is available when the PWR (Power) LED has turned from red to green, around 40 seconds after powering on the STREAM AMP.

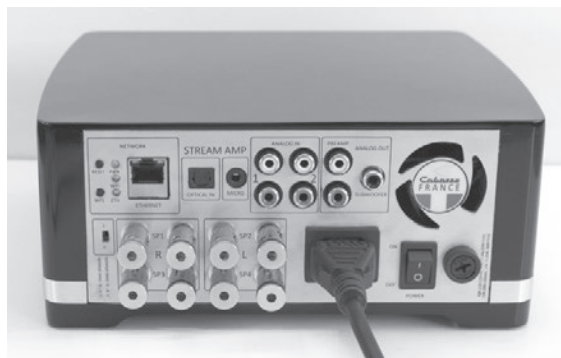

3

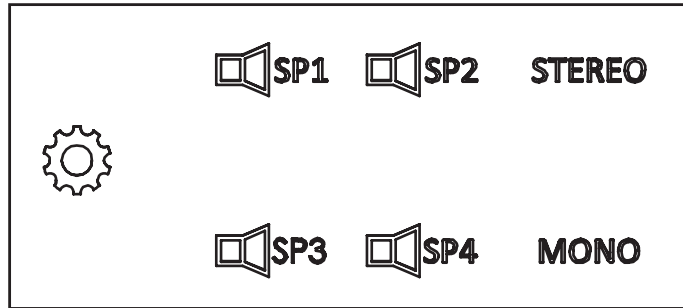

Settings of the loudspeakers outputs .

Press  to select between the 4 possible set-ups:

- 1 STEREO pair of loudspeakers (default mode). The SP1, SP2, STEREO LEDs are on.
- 2 STEREO pairs of loudspeakers. The SP1, SP2, SP3, SP4 and STEREO LEDs are on.
- 2 loudspeakers playing MONO. The SP1, SP2 and MONO LEDs are on.
- 4 loudspeakers playing MONO. The SP1, SP2, SP3, SP4 and MONO LEDs are on.

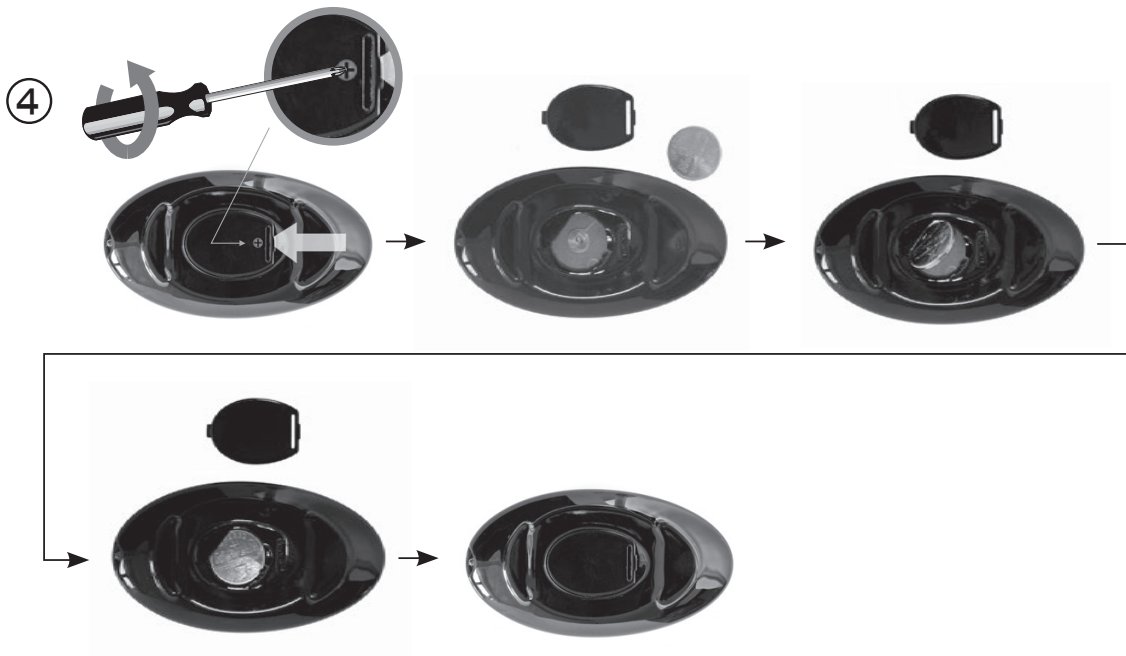

Before first use, loosen the screw (PH00 screwdriver), remove the back cover, remove the battery protection tab, replace the cover, retighten the screw.

Replacement of the CR-2025 type battery in the Stream remote control: loosen the screw, remove the rear lid, remove the old battery and load the new battery properly with the "+" side on the clasp side, put the rear cover back on, retighten the screw.

5



Once the Bluetooth and Wi-Fi connections activated, press the **8** key of the remote control or on the front panel until you get the requested source, with the appropriate LED on the panel being on. The Wifi LED stands for the Wifi/WLAN source, the ETH LED stands for the Ethernet/LAN source.

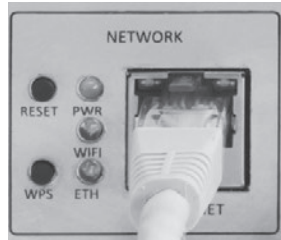

6

ANALOG INPUTS 1 AND 2

Select an audio source fitted with an analogue output, either RCA or mini-jack type. Get a RCA/mini-jack if the source is fitted with a mini-jack output.



7

USB INPUT

Plug in a USB stick or a hard-drive to this input to get all the stored audio files available on the domestic network. All the audio files, under formats compatible with the built-in DLNA server of STREAM AMP, will be listed in the Stream Audio Control apps and can be played by any Cabasse Stream player connected to the same domestic network. The USB input is fitted with a 1 ampere power output enabling the use of a portable hard drive with no need of an external power supply.



BLUETOOTH CONNECTION

STREAM AMP is set in on open mode for Bluetooth connections.

Select "Cabasse STREAM AMP" in the available Bluetooth devices list. Select the BLUETOOTH input with **(E)** key on the Stream remote or on the Stream Amp. If a Bluetooth source is already connected to STREAM AMP, disconnect this item before selecting a new one.

BLUETOOTH CONNECTION WITH AN ANDROID TABLET: see the English explanation on page 38.

CONNECTION AND USE OF STREAM AMP WITH AN APPLE COMPUTER: see the English version page 39.

INSTANT NFC BLUETOOTH CONNECTION WITH A NFC SMARTPHONE

1) Installation of the Cabasse NFC application

- a) Enable the NFC function in the set up of the NFC smartphone.
- b) Check/activate the wifi or 3G connection of the smartphone to Internet.
- c) Touch the smartphone together with the NFC patch **(1D)** in the middle of the front panel of STREAM AMP.
- d) Accept the installation of the Cabasse NFC app from Google Play.
- e) Your smartphone is now ready for instant Bluetooth NFC connections.

2) Using the Cabasse Bluetooth NFC application

- a) Tap your smartphone on the NFC patch **(1D)** in the middle of the STREAM AMP for instant Bluetooth pairing; if necessary the STREAM AMP turns on, then the Bluetooth input is automatically selected and the first cut of the smartphone's playlist is being played by STREAM AMP.
- b) Tap again to unpair both items and before pairing another smartphone to the STREAM AMP.

NOTE: The Cabasse NFC application runs in background once installed in the smartphone. This application can be found in the list of applications, but there is no icon on the desktop.

LAN WIRE CONNECTION TO THE ETHERNET NETWORK

The LAN wire connection ensures a constant and optimum transfer rate. Use it if music reproduction stops or is erratic under Wi-Fi mode, because of a saturated Wi-Fi bandwidth or the distance between the router and the Stream unit being too long.

Use a RJ45 type cable to connect STREAM AMP to the domestic router.

The connection is running when the blue LED "ETH" stops flashing and remains on.

ATTENTION: set up the router on DHCP mode.

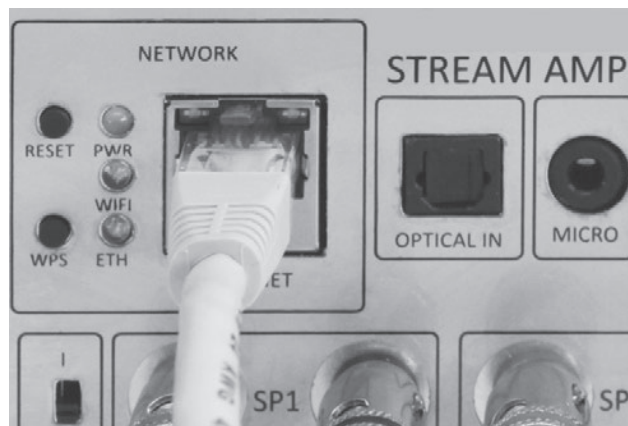

Press "RESET" before starting a new connection process (wired, auto, easy, manual) or connecting to a new router.

WIFI DIRECT MODE

Wi-Fi direct allows to play with wifi quality all the audio tracks available in the tablet or the smartphone as well as those available in the hard-disk or USB-stick connect to the USB input of STREAM AMP, without need of a wifi network. Internet sources such as Vtuner, Deezer and the STREAM AMP firmware updates are not available.

Activate the STREAM AMP, Install and open the Cabasse app on your tablet/smartphone and select "Use this device in standalone mode" instead of "configure this audio device". Follow the instructions and start playing your music.

DLNA (WLAN) WIRELESS CONNECTION TO THE WIFI NETWORK

THERE ARE 2 SOLUTIONS TO CONNECT STREAM AMP TO THE WIFI NETWORK:

1) WPS CONNECTION: push the WPS button of the wireless router for 2 seconds or more and push the WPS button of the STREAM AMP within around 2 minutes (check for precise delays in the router's manual). The connection is completed when the blue LED "WIFI CONFIGURATION" is on. Now go to page 41 to install the Cabasse application.

2) EASY WI-FI CONNECTION WITH THE CABASSE STREAM APP

& with a smartphone or tablet wi-fi connected to the domestic network.

- a) Install the Cabasse Stream App on an Android or Mac tablet or smartphone from "Play Store" or "App Store".
- b) Switch the STREAM AMP on or press the reset button if already on. Activate the Wi-Fi in the "settings" application mode of the smartphone or tablet.
- c) Select STREAM AMP among the available items and launch the connection.
- d) Launch the Cabasse Stream app. Once connected to STREAM AMP, select STREAM AMP in the available wifi networks list and follow the set-up instructions.

Note: from phase b), you may open the Cabasse application and follow the instructions of the online guide, which is launched automatically when connecting for the first time.

- e) The Wifi blue LED on the back of STREAM AMP flashes for around 30 seconds.
- f) The Wifi blue LED stops flashing and remains on: press on "Close This Window". STREAM AMP is now ready to play all the shared audio files in your network as well as all the web radios proposed by vTuner.

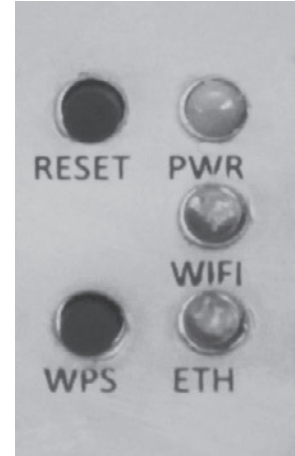

CAUTION! An automatic update of the firmware might start as soon as STREAM AMP is connected to the Web. The ⑨ LED turn to white and flashes for 5 to 15 minutes until the update is fully completed.

Do not try to use STREAM AMP during the update, wait until STREAM AMP has restarted, when ⑨ LED is steady red. Press ① to turn the STREAM AMP on and carry on.

Do not shut down or unplug STREAM AMP during updates.

Thank you very much for choosing Cabasse speakers. Please read these instructions carefully before setting up your speakers.

IMPORTANT SAFETY INSTRUCTIONS

Explanation of graphical symbols



- The lightning flash with arrowhead symbol, within an equilateral triangle, is intended to alert you to the presence of uninsulated “dangerous voltage” within the product’s enclosure that may be of sufficient magnitude to constitute a risk of electric shock to persons.

The exclamation point within an equilateral triangle is intended to alert you to the presence of important operating and maintenance (servicing) instructions in the literature accompanying the appliance.

Cleaning - Always take off the power cord before cleaning the device. Do not use cleaning solvent, whether liquid or air spray. Using a soft damp cloth is recommended.

Installation on a piece of furniture and stands - Do not place this device on an unsteady surface, i.e. a stand, tripod, table, shelf, etc. It may fall and cause serious injury to a nearby child or adult.

Ventilation outlets - The device shall not be placed in a position that restrains the operation of its fans. Avoid installing the device on a bed, couch, blanket or other similar surfaces that may prevent the appropriate air flow. Do not install the device in a confined space, such as a book shelf or other piece of furniture, that could prevent sufficient air from flowing freely.

Power - The device shall only be connected to a source of power compliant to the one described in this manual or on relevant printed labels on the product. If you are not sure of the

type of power available, please contact your reseller or the local power company.

Easy access to mains plug - To completely disconnect this product from the mains, disconnect the plug from the wall socket outlet. The mains plug is used to completely interrupt the power supply to the unit and must be within easy access by the user.

Overloads - Avoid overloading the power plugs, extension cords or power relays. This could result in fire or electric shocks.

Foreign bodies and liquids - Avoid letting foreign materials or liquids enter the device. They could cause fire or electric shocks. Never spill any liquid on the device.

Troubleshooting - You must unplug your device from the power supply and have it checked by a qualified technician if:

- The power supply or the plug is damaged.
- Foreign bodies or liquid penetrated the device.
- The device was exposed to dripping or splashing.
- The device does not seem to work correctly under normal operating conditions. Only operate the controls described in this manual. Any other operation could damage the device and require on-site visit of a qualified technician.
- The device has fallen or its housing is damaged.
- The performances of the device are strongly altered.

Spare parts - If spare parts are needed to repair the device, make sure that the technician followed the manufacturer's recommendations or that the replacing parts feature the same specifications as the original ones. Non-compliant parts can result in multiple damages, including fire or electric shocks.

Checks - After any servicing of the device, ask the technician to perform appropriate testing to make sure that the device works safely.

IMPORTANT SAFETY INSTRUCTIONS

1. READ these instructions.
2. KEEP these instructions.
3. HEED all warnings.
4. FOLLOW all instructions.
5. DO NOT use this apparatus near water.
6. CLEAN ONLY with dry cloth.
7. DO NOT block any ventilation openings. Install in accordance with the manufacturer's instructions.
8. DO NOT install near any heat sources such as radiators, heat registers, stoves, or other apparatus (including amplifiers) that produce heat.
9. DO NOT defeat the safety purpose of the polarized or grounding type plug. A polarized plug has two blades with one wider than the other. A grounding type plug has two blades and a third grounding prong. The wider blade or the third prong are provided for your safety. If the provided plug does not fit into your outlet, consult an electrician for replacement of the obsolete outlet.

10. PROTECT the power cord from being walked on or pinched, particularly at plugs, convenience receptacles, and the point where they exit from the apparatus.

11. ONLY USE attachments/accessories specified by the manufacturer.

12. USE ONLY with a cart, stand, tripod, bracket, or table specified by the manufacturer, or sold with the apparatus.



When a cart is used, use caution when moving the cart/apparatus combination to avoid injury from tip-over.

13. UNPLUG this apparatus during lightning storms or when unused for long periods of time.

14. REFER all servicing to qualified service personnel. Servicing is required when the apparatus has been damaged in any way, such as power-supply cord or plug is damaged, liquid has been spilled or objects have fallen into the apparatus, the apparatus has been exposed to rain or moisture, does not operate normally, or has been dropped.

The mains plug is used as the disconnect device, the disconnect device shall remain readily operable.



Warning: don't ingest battery, chemical burn hazard

UNPACKING

Open carton flaps; remove all the components. If the speakers or the subwoofer appear damaged, do not use them. Repack everything in the original packing and contact your authorised Cabasse dealer immediately. We suggest you to retain the packing for future use.

SETTING UP

THE COMPONENTS OF YOUR SYSTEM

- 1 STREAM AMP, 1 power cord, 1 optical cable, 1 RCA-RCA cable, 1 remote control, 1 manual and one warranty card.

INSTALLATION

- Place STREAM AMP within reach of a mains plug.
- Leave enough free room above and around STREAM AMP in order to:
 - allow good wifi and Bluetooth transmission,
 - give access to a smartphone for easy NFC tap Bluetooth connection.
 - provide a good air circulation for cooling.

POWER CONNECTION

- Connect the power cord to the STREAM AMP, plug it into the mains and position the POWER ON/OFF switch to "ON" Stream Amp is ready to play when the LED ⑨ turns on.

NOTE: the WIFI mode of STREAM AMP is available when the PWR (Power) LED has turned from red to green, around 40 seconds after switching on the STREAM AMP.

ON / ECO

a) Switching to ECO mode: press the ① key of the Stream remote control or of the STREAM AMP keypad. The wifi and Bluetooth functions remain available. The audio section of STREAM AMP is no longer powered.

b) Getting back to ON mode:

- press the ① key of the Stream remote control or of the STREAM AMP keypad or
- launch a Bluetooth connection (NFC or other) or
- press "Play" on the StreamCONTROL application.

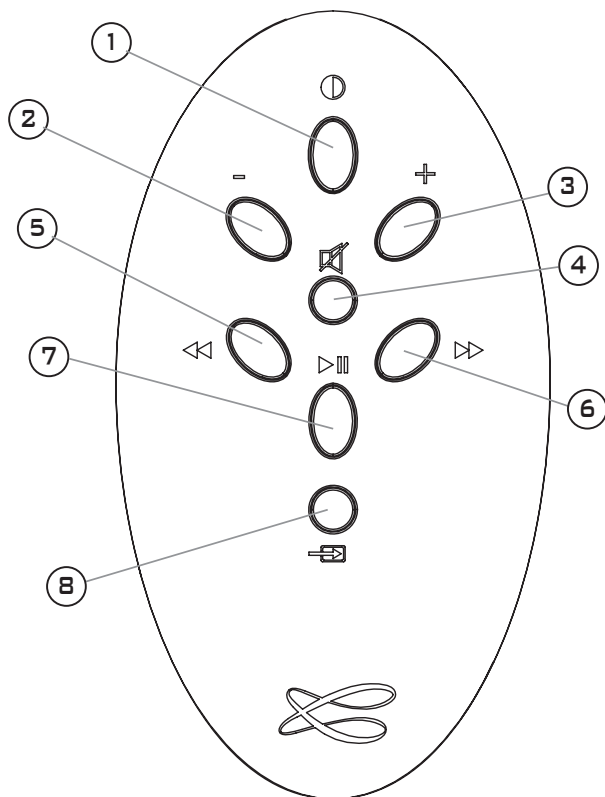
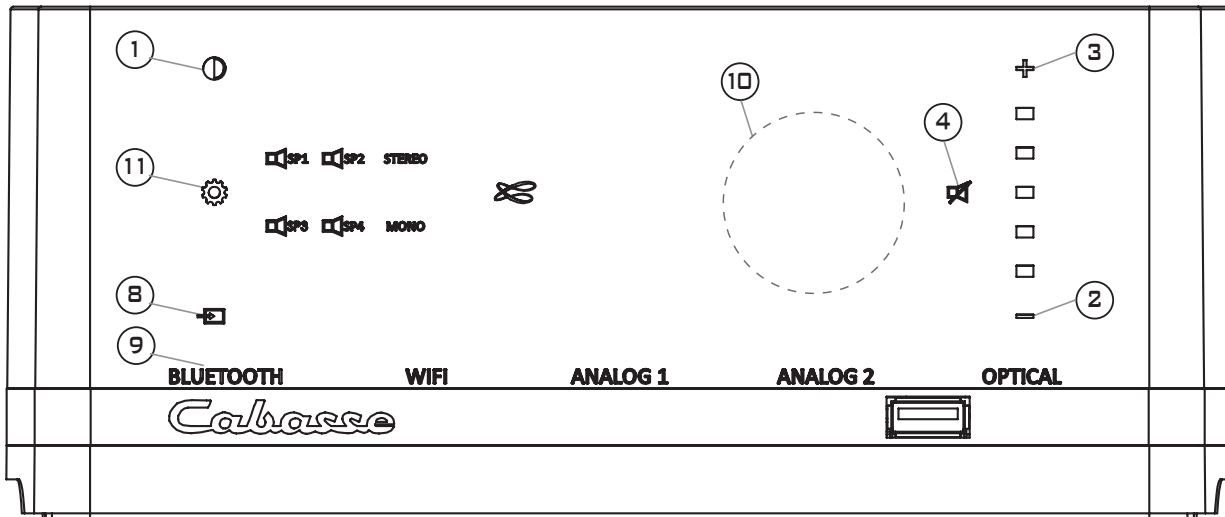

USE OF STREAM AMP WITH CONTROL KEYS AND THE STREAM REMOTE CONTROL

- ① ECO / ON mode selection
- ② ③ ④ VOL "+" and "-", Mute keys
- ⑤ and ⑥ wifi: reverse and forward scanning
- Bluetooth: previous and next title of the played album or playlist.
- ⑦ Music: play or pause (wifi and Bluetooth)
- ⑧ Source selection: press this key to select one of the connected sources: Bluetooth (blue LED ⑨), wifi (orange LED ⑨) or analogue (green LED ⑨).

BLUETOOTH CONNECTION TO AN ANDROID TABLET

- If not already done, activate the Bluetooth Function in the « Settings » menu of your tablet by pressing on the ON-OFF switch.

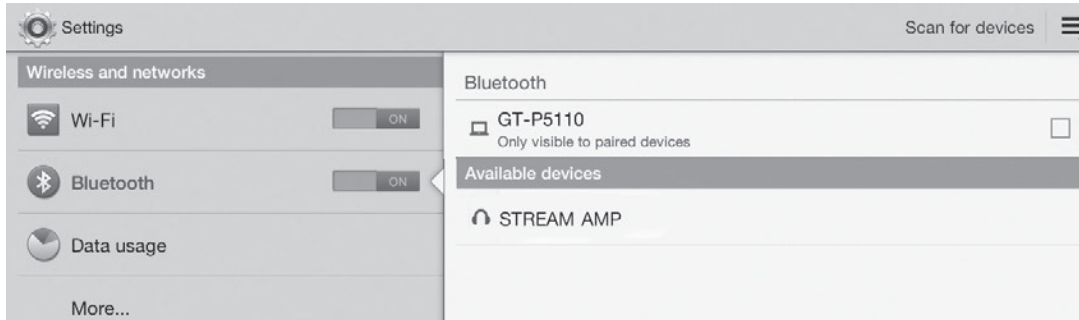

- Press “Scan for devices” and select « Cabasse STREAM AMP » among the available devices.

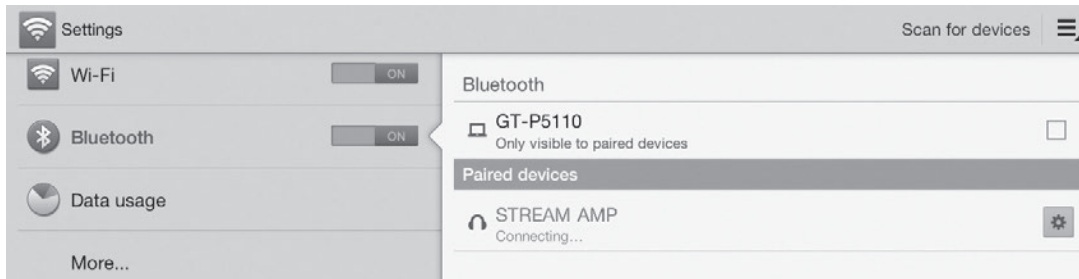

STREAM AMP is now paired with the tablet and connected to STREAM AMP is no other Bluetooth connection to STREAM AMP is active.

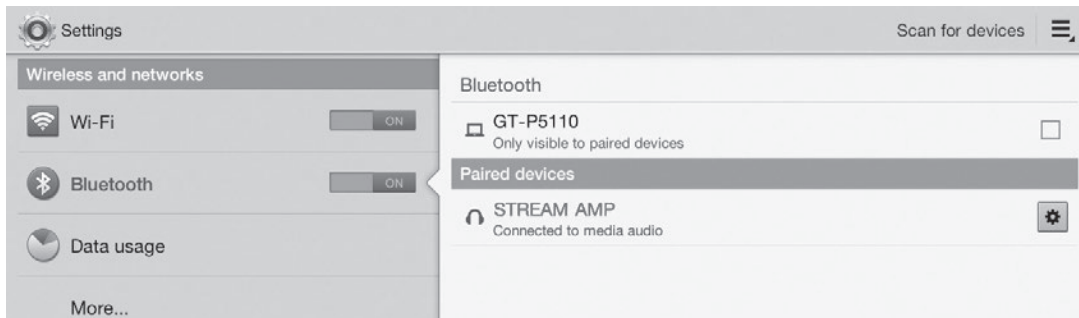

If the message « Connection.. » does not show up, stop the running Bluetooth connection with another device, either through the set up menu of the device or by switching off and on the STREAM AMP. Press on « Cabasse STREAM AMP » again.

To play on STREAM AMP the audio files stored in the tablet (or smartphone), open the audio player application, select a file and press on “play”.

If STREAM AMP remains silent, first check that the main volume of the tablet (or smartphone) is not down to zero level and that « mute » is off. Adjust the volume in the player application and finally raise the volume of the STREAM AMP with the Stream remote. Finally select « Bluetooth » as the active source on STREAM AMP pressing the **(B)** key of the Stream remote until the blue LED flashes.

INSTANT BLUETOOTH CONNECTION VIA NFC TAGS See page 31.

BLUETOOTH CONNECTION TO AN APPLE COMPUTER

1) BLUETOOTH MODE ACTIVATION

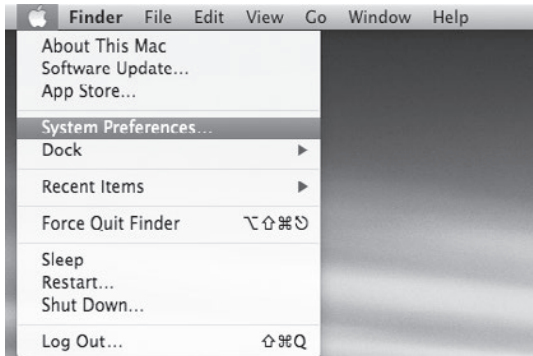

Connect the STREAM AMP to mains to power it on. If STREAM AMP is already on, stop any running Bluetooth connection between STREAM AMP and any other item. Activate the Bluetooth function of the computer: open the « apple » menu and select « Systems Preferences ».

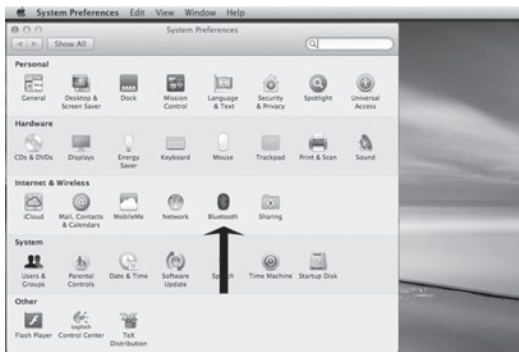

Select « Bluetooth » in the window for the « Systems Preferences ».

Select « On » and click on « Set Up New Device »

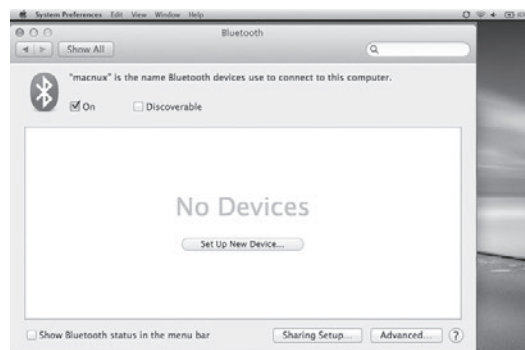

Select « STREAM AMP » in the list of items and click on “Continue”

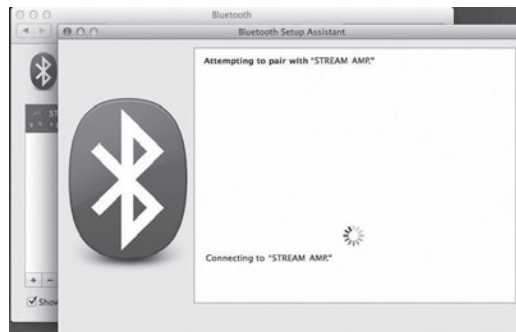

Connecting...



Connection completed. STREAM AMP is now paired with your Mac computer.

2) SELECTION OF THE AUDIO OUTPUT DEVICE

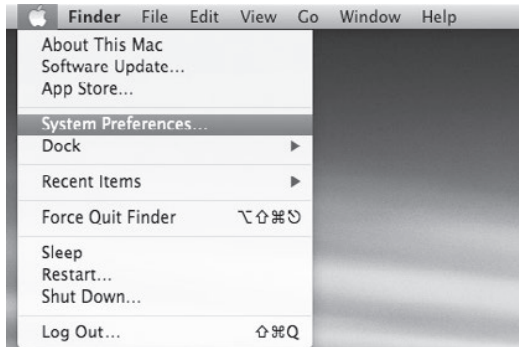

To enjoy the music stored on your Mac with STREAM AMP, set up STREAM AMP as your audio output device in the “System Preferences” menu.

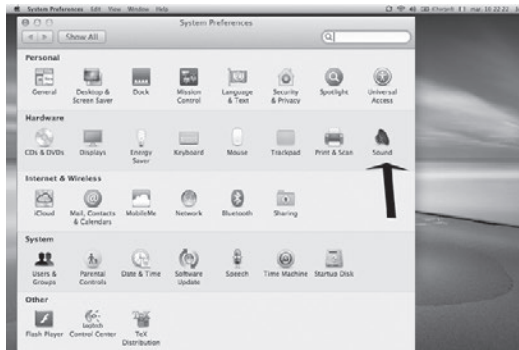

Select « Sound » in the « Hardware » section.

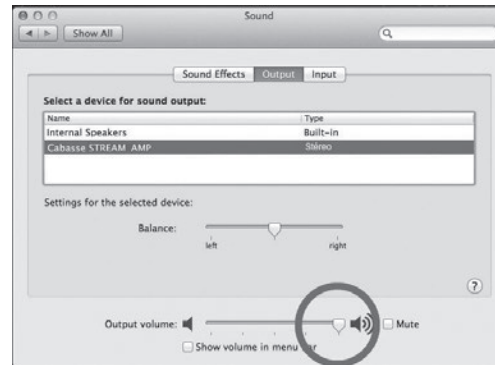

Select "STREAM AMP Stereo" in the « Output » tab. The line "STREAM AMP" stands for the hands free set up to be used only with a smartphone.

Set the volume control on far right position. Close the “Sound” window.

If the STREAM AMP is on Eco mode, it will take around 6 seconds to start playing, the Bluetooth input being automatically selected. Use the Stream remote control to adjust the sound level.

If STREAM AMP is active and connected to another active source (wifi, analog) use the Stream remote control and select the Bluetooth input with the **(B)** key, then adjust the sound level.

USE OF STREAM AMP WITH StreamCONTROL APP

- 1** - Switch ON the POWER button on the back of the STREAM AMP. STREAM AMP IS ready to play when the LED ① illuminates red (stand-by mode), press key ① on the front board of STREAM AMP or on the remote control to get STREAM AMP on.
- 2** - Connect the smartphone or the tablet to the WLAN network to be used with STREAM AMP.
- 3** - Download and install the free application names StreamCONTROL on Playstore for Android or on the App Store for iOS.
- 4** - Launch the application and follow the instructions from the setup wizard. Choose between direct Wi-Fi (see page 32) or network mode (see pages 33) upon request.

The app is easy to use

When necessary (after an application update for instance), pressing the “?” key gives specific help and hints at each level of navigation.

You can now enjoy Stream, play all the audio files listed in your smartphones or tablets, PC and Mac computers, NAS hard disks, as well as the HD or USB sticks directly connected to any Stream Amp, Stream Source or Stream 1 connected to the network, discover thousands of web radios and stream with Deezer.

All the Stream players of the same network can be controlled by one or several smartphones and tablets. Groups of Stream players connected the same way (LAN or WLAN) can be created to play synchronised music with individual level control.



DEAP function

This function is unique to Stream AMP. The Digital Enhancement of Acoustical Performance available in Stream Amp enables to optimize the response of your Cabasse speakers and takes into account their location in the room. To activate the function, open the “settings” section of the Stream Control app, select “players”, then “Stream AMP”. Press on the DEAP logo, select the type of your speaker from the list, select the appropriate speakers positions (free standing, against the rear wall, in room corners. Save the settings. Your system is ready.

BATTERY REPLACEMENT

Take the remote control in your hand with the keyside facing the floor. Lift the locker and pull out the battery. Remove the dead battery and replace it with a new CR-2025 battery. Dispose of the old batteries according to these instructions.



CAUTION: *there is a danger of explosion if the battery is incorrectly replaced. Replace only with the same or equivalent type. The battery shall not be exposed to excessive heat such as sunshine, fire or the like.*

WEEE MARK

Disposal of Wastes of Electrical & Electronic Equipment (Applicable in the European Union)



This symbol on the product, consisting of the crossed-out wheeled bin, indicates that this product shall not be treated as household waste. Instead it shall be handed over to the applicable collection point for the disposal of electrical and electronic equipment at the end of life. By ensuring this product is disposed of correctly, you will help prevent potential negative consequences for the environment and human health, which could otherwise be caused by inappropriate waste handling of this product. The recycling of materials will help to preserve natural resources. For more detailed information about recycling of this product, please contact your local city office, your household waste disposal service or the shop where you purchased the product.

AUTO UPDATE

The updates of the firmware for STREAM AMP are done automatically. The duration of an update can vary from 5 minutes to half an hour.

The ① LED turns to red and flashes until the update is fully completed. STREAM AMP cannot be used during the updates.



ATTENTION: *Do not shut down STREAM AMP during updates.*

CLEANING STREAM AMP

The STREAM AMP may be cleaned with a soft damp cloth. Do not use any sprays near the system or allow liquids to spill into any openings. Also, do not use any solvents, chemicals, or cleaning solutions containing alcohol, ammonia, or abrasives.

FAQ

Looking for more information? Read our detailed answers to the Frequency Asked Question on www.cabasse.com, page STREAM.

CUSTOMER SUPPORT SERVICE

The Cabasse retailer network is at your disposal to ensure the after sale service of your product. To get the list of Cabasse retailers, contact us or consult our web site www.cabasse.com.

By following the above instructions, your STREAM AMP system is now properly set up and we hope you will enjoy your speaker system for many years. We receive letters every day from customers expressing the ever growing satisfaction and musical emotion they have been getting with our speakers over the years. These letters are our first motivation.

STREAM AMP 100

Digital inputs	<ul style="list-style-type: none"> - 1 DLNA input: either wired with RJ45 cable or Wifi - 1 Bluetooth APTX input - 1S/PDIF optical - 1 USB input
Analogue input	2 stereo RCA
NFC[®])	NFC patch in the center of the front panel Instant Bluetooth Connection
Voltage	110-240V~60/50 Hz, 2A
Power consumption	150W
Eco power consumption	11 W @ 110-240VAC~50/60Hz
Power consumption when off	0 W @ 110-240VAC~50/60Hz
Useable temperature range	+5 °C to +35 °C
Storage temperature	-5 °C to +40 °C
Useable humidity range	40 % to 70 %
Network	10/100Mb Ethernet MAC & PHY Wireless LAN 802.11b/g/n WPS 2.0 security Digital media renderer (compliant with DLNA 1.5)
Audio formats (WiFi/RJ45)	WMA (WMA9, CBR,CBR, up to 320kbps) PCM (16 bits-44.1kHz, 24 bits-44/48/96 kHz, .wav, .aiff, .aif, .aifc files, HTTP streams) AAC-LC (up to 320kbps), ALAC (.m4a) FLAC (16 bits-44.1kHz, 24 bits- 44/48/96 kHz)
Amplification	2 x 50 W RMS/4-8 ohms or 4 x 25 W RMS/4-8 ohms
Distortion rate and noise <small>(THD+N for the 20-20,000 Hz bandwidth and for 100 mW power output and more)</small>	Wifi : < 0,1% Bluetooth : < 0,1% Analogue : < 0,1% Optical < 0.1% THD+N
Dimensions (H x W x D)	91 x 218 x 190 mm / 3.58 x 8.58 x 7.48 in
Weight	1.9 kg - 4.2 lbx

FEATURES

	Bluetooth connection	WIFI/ETHERNET via internet router	WIFI direct to smartphone/tablet
Loss less audio playback		☐	☐
Access to any audio from WLAN network (desktop...)		☐	
Multi-room		☐	
Tracks playback from smartphone/tablet	☐	☐	☐
Playback smartphone/tablet a audio applications (youtube...)	☐		
Playback from USB device		☐	☐
Web radio /DEEZER		☐	



Manufactured under licence from Dolby Laboratories.
Dolby and the double D symbol are trademarks of Dolby Laboratories.

FCC STATEMENT

This equipment has been tested and found to comply with the limits for a Class B digital device, pursuant to Part 15 of the FCC Rules. These limits are designed to provide reasonable protection against harmful interference in a residential installation. This equipment generates uses and can radiate radio frequency energy and, if not installed and used in accordance with the instructions, may cause harmful interference to radio communications. However, there is no guarantee that interference will not occur in a particular installation. If this equipment does cause harmful interference to radio or television reception, which can be determined by turning the equipment off and on, the user is encouraged to try to correct the interference by one or more of the following measures:

- Reorient or relocate the receiving antenna.
- Increase the separation between the equipment and receiver.
- Connect the equipment into an outlet on a circuit different from that to which the receiver is connected.
- Consult the dealer or an experienced radio/TV technician for help.

This device complies with part 15 of the FCC Rules. Operation is subject to the following two conditions :(1) This device may not cause harmful interference, and (2) this device must accept any interference received, including interference that may cause undesired operation.

Changes or modifications not expressly approved by the party responsible for compliance could void the user's authority to operate the equipment.

This equipment complies with FCC radiation exposure limits set forth for an uncontrolled environment. This equipment should be installed and operated with minimum distance 20cm between the radiator & your body.



Cabasse

Cabasse SA - 210, rue René Descartes - BP 10 - 29280 Plouzané
Tel +33 (0)2 98 05 88 88 - Fax +33 (0)2 98 05 88 99
www.cabasse.com